

R/W SPECIALTIES STAIR PARTS

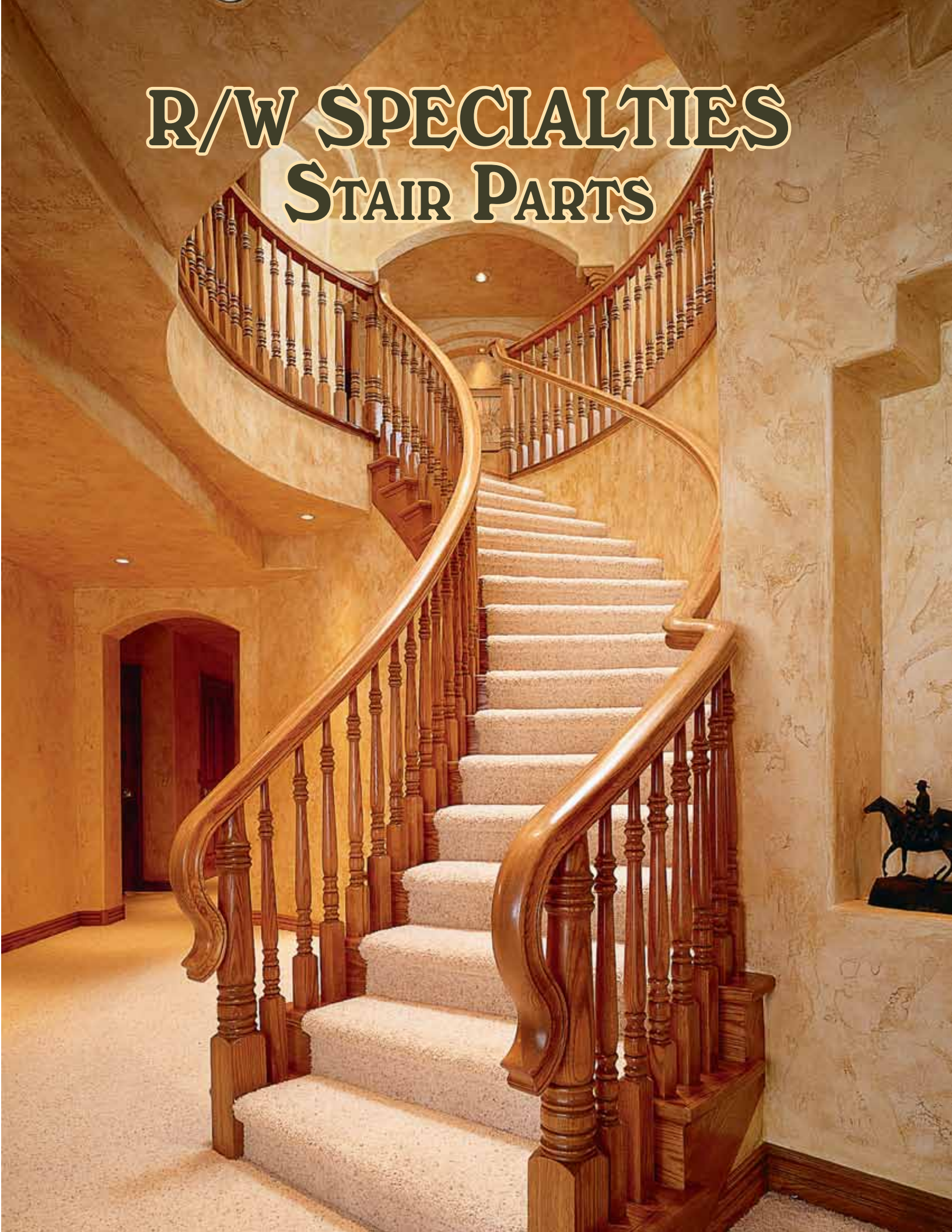

Newel Posts

All Newels are Individually Carton Packed.

Newel Top Dowel Pins are 1" in length and 3/4" diameter.

1/2 NEWELS are Available at 75% of the Full Newel Price. Full Newels Split, Add \$10.00.

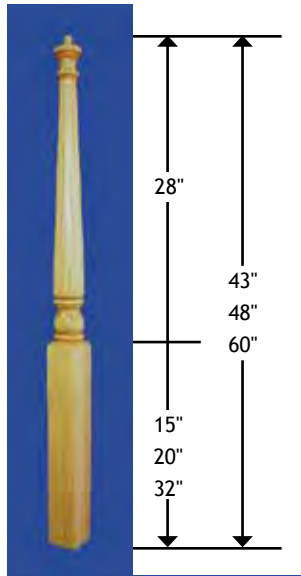

3" Square			
Oak / Maple	Cherry	Alder	
4010	\$55.00	--	--
4011	63.00	\$100.00	\$74.00
4015	74.00	120.00	92.00
3-1/4" Square			
GNP-448		Hemlock	\$42.00
GNP-460			52.00

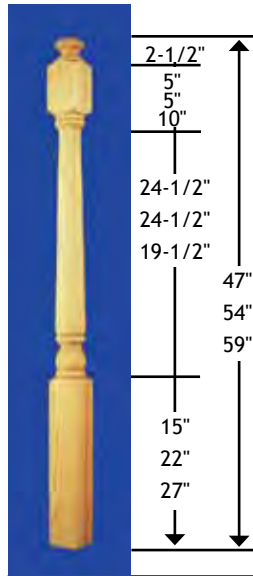

3" Square			
Oak / Maple	Cherry		
4140	\$63.00	\$100.00	
4142	68.00	110.00	
4145	74.00	120.00	
3-1/4" Square			
ENP-448		Hemlock	\$42.00
ENP-460			52.00

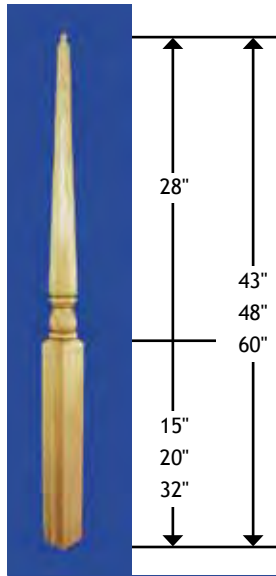

3" Square		
Oak		
4030	\$63.00	
4031	66.00	
4035	76.00	
3-1/4" Square		
HNP-448		Hemlock \$42.00
HNP-460		52.00

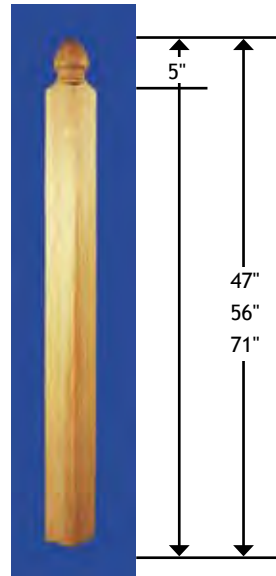

3-1/2" Square			
Oak	Alder		
4004	\$ 81.00	--	
4005	94.00	--	
4005-BT	--	98.00	
3-1/4" Square			
SNP-448		Hemlock	\$42.00
SNP-460			52.00

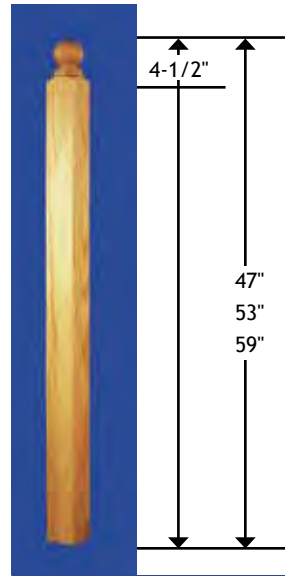

3" Square			
Oak			
4070	\$63.00		
4072	68.00		
4073	74.00		
3-1/4" Square			
RNP-448		Hemlock	\$42.00
RNP-460			52.00

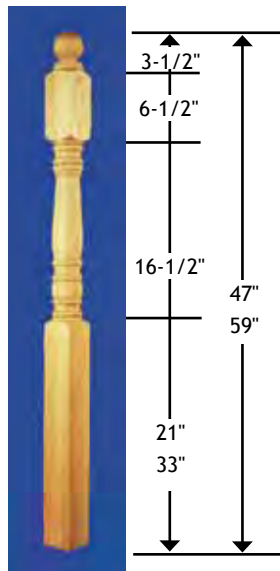

3" Square		
Oak		
4300	\$63.00	
4301	74.00	
3-1/4" Square		
DNP-448		Hemlock \$42.00
DNP-460		52.00

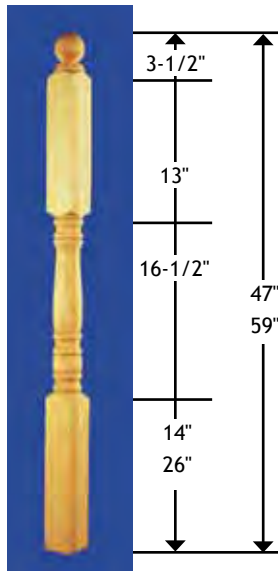

3" Square		
Oak		
4304	\$63.00	
4305	74.00	
3-1/4" Square		
ONP-448		Hemlock \$42.00
ONP-460		52.00

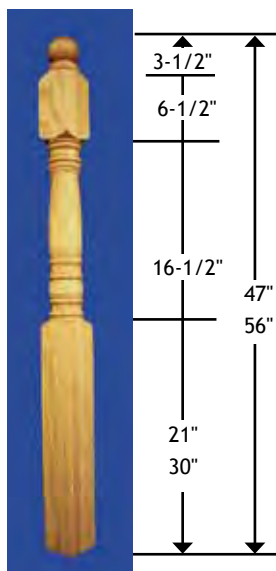

3-1/2" Square		
Oak		
4500	\$81.00	
4501	94.50	

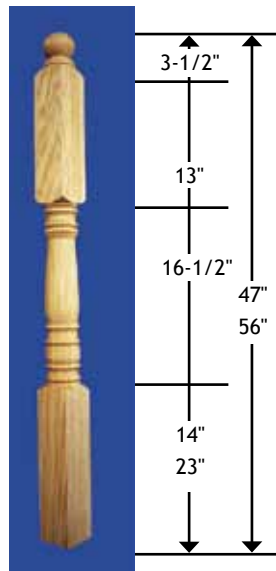

3-1/2" Square		
Oak		
4504	\$81.00	
4505	94.50	

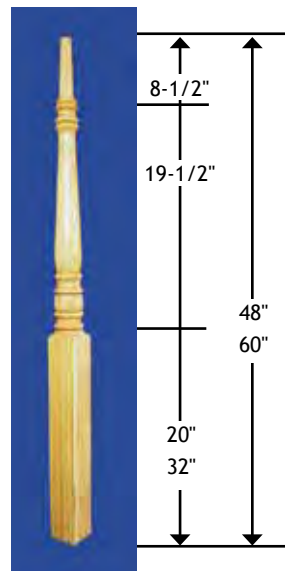

3" Square		
Oak		
4211	63.00	
4215	74.00	
3-1/4" Square		
LNP-460		Hemlock 52.00

For More **NEWEL ATTACHING Kits** & **NEWEL FASTENING Bolts**

See Pages 16 & 17. **Fluting** or **Twisting** of Newel Posts Available

Newels with Top Dowels are Used with Fittings Shown on Pages 12 & 13.



EXTRA LARGE NEWELS, FLUTED NEWELS & S4S NEWEL BLANKS Shown on pages 4 & 5.

<p>3" Square</p> <table border="1"> <tr><th></th><th>Oak</th><th>Maple</th></tr> <tr><td>4040</td><td>\$63.00</td><td>\$63.00</td></tr> <tr><td>4042</td><td>68.00</td><td>--</td></tr> <tr><td>4043</td><td>74.00</td><td>--</td></tr> </table> <p>3-1/4" Square</p> <table border="1"> <tr><th></th><th>Hemlock</th></tr> <tr><td>KNP-448</td><td>\$42.00</td></tr> <tr><td>KNP-460</td><td>52.00</td></tr> <tr><td>KNP-460BT</td><td>52.00</td></tr> </table>		Oak	Maple	4040	\$63.00	\$63.00	4042	68.00	--	4043	74.00	--		Hemlock	KNP-448	\$42.00	KNP-460	52.00	KNP-460BT	52.00	<p>3" Square</p> <table border="1"> <tr><th></th><th>Oak</th><th>Maple</th></tr> <tr><td>4044</td><td>\$68.00</td><td>--</td></tr> <tr><td>4045</td><td>74.00</td><td>\$74.00</td></tr> <tr><td>4046</td><td>74.00</td><td>--</td></tr> </table> <p>3-1/4" Square</p> <table border="1"> <tr><th></th><th>Hemlock</th></tr> <tr><td>PNP-448</td><td>\$42.00</td></tr> <tr><td>PNP-460</td><td>52.00</td></tr> <tr><td>PNP-461</td><td>52.00</td></tr> </table>		Oak	Maple	4044	\$68.00	--	4045	74.00	\$74.00	4046	74.00	--		Hemlock	PNP-448	\$42.00	PNP-460	52.00	PNP-461	52.00	<p>3" Square</p> <table border="1"> <tr><th></th><th>Oak</th></tr> <tr><td>4040BT</td><td>\$63.00</td></tr> <tr><td>4043BT</td><td>74.00</td></tr> <tr><td>4044BT</td><td>68.00</td></tr> <tr><td>4045BT</td><td>74.00</td></tr> </table> <p>3-1/4" Square</p> <table border="1"> <tr><th></th><th>Hemlock</th></tr> <tr><td>PNP-448BT</td><td>\$42.00</td></tr> <tr><td>PNP-460BT</td><td>52.00</td></tr> </table>		Oak	4040BT	\$63.00	4043BT	74.00	4044BT	68.00	4045BT	74.00		Hemlock	PNP-448BT	\$42.00	PNP-460BT	52.00	<p>3" Square</p> <table border="1"> <tr><th></th><th>Oak / Maple</th><th>Alder</th></tr> <tr><td>5711</td><td>\$63.00</td><td>--</td></tr> <tr><td>5715</td><td>74.00</td><td>95.00</td></tr> </table> <p>3-1/2" Square</p> <table border="1"> <tr><th></th><th>Oak / Maple</th><th>Alder</th></tr> <tr><td>5511</td><td>\$86.00</td><td>--</td></tr> <tr><td>5515</td><td>110.00</td><td>115.00</td></tr> </table>		Oak / Maple	Alder	5711	\$63.00	--	5715	74.00	95.00		Oak / Maple	Alder	5511	\$86.00	--	5515	110.00	115.00	<p>3" Utah</p> <table border="1"> <tr><th></th><th>Oak/Maple</th><th>Alder</th></tr> <tr><td>5748</td><td>\$63.00</td><td>\$74.00</td></tr> <tr><td>5760</td><td>74.00</td><td>92.00</td></tr> </table>		Oak/Maple	Alder	5748	\$63.00	\$74.00	5760	74.00	92.00	<p>3-1/2" Utah</p> <table border="1"> <tr><th></th><th>Oak/Maple</th><th>Alder</th></tr> <tr><td>5548</td><td>\$81.00</td><td>--</td></tr> <tr><td>5554</td><td>--</td><td>103.00</td></tr> <tr><td>5560</td><td>110.00</td><td>115.00</td></tr> <tr><td>5546</td><td>110.00</td><td>115.00</td></tr> </table>		Oak/Maple	Alder	5548	\$81.00	--	5554	--	103.00	5560	110.00	115.00	5546	110.00	115.00
	Oak	Maple																																																																																																					
4040	\$63.00	\$63.00																																																																																																					
4042	68.00	--																																																																																																					
4043	74.00	--																																																																																																					
	Hemlock																																																																																																						
KNP-448	\$42.00																																																																																																						
KNP-460	52.00																																																																																																						
KNP-460BT	52.00																																																																																																						
	Oak	Maple																																																																																																					
4044	\$68.00	--																																																																																																					
4045	74.00	\$74.00																																																																																																					
4046	74.00	--																																																																																																					
	Hemlock																																																																																																						
PNP-448	\$42.00																																																																																																						
PNP-460	52.00																																																																																																						
PNP-461	52.00																																																																																																						
	Oak																																																																																																						
4040BT	\$63.00																																																																																																						
4043BT	74.00																																																																																																						
4044BT	68.00																																																																																																						
4045BT	74.00																																																																																																						
	Hemlock																																																																																																						
PNP-448BT	\$42.00																																																																																																						
PNP-460BT	52.00																																																																																																						
	Oak / Maple	Alder																																																																																																					
5711	\$63.00	--																																																																																																					
5715	74.00	95.00																																																																																																					
	Oak / Maple	Alder																																																																																																					
5511	\$86.00	--																																																																																																					
5515	110.00	115.00																																																																																																					
	Oak/Maple	Alder																																																																																																					
5748	\$63.00	\$74.00																																																																																																					
5760	74.00	92.00																																																																																																					
	Oak/Maple	Alder																																																																																																					
5548	\$81.00	--																																																																																																					
5554	--	103.00																																																																																																					
5560	110.00	115.00																																																																																																					
5546	110.00	115.00																																																																																																					

<p>3" Square</p> <table border="1"> <tr><th></th><th>Oak</th><th>Cherry</th></tr> <tr><td>2910</td><td>\$63.00</td><td>\$94.00</td></tr> <tr><td>2915</td><td>75.00</td><td>120.00</td></tr> </table> <p>3-1/4" Square</p> <table border="1"> <tr><th></th><th>Hemlock</th></tr> <tr><td>ANP-460</td><td>52.00</td></tr> </table>		Oak	Cherry	2910	\$63.00	\$94.00	2915	75.00	120.00		Hemlock	ANP-460	52.00	<p>3" Square</p> <table border="1"> <tr><th></th><th>Oak</th><th>Cherry</th></tr> <tr><td>2940</td><td>\$66.00</td><td>\$100.00</td></tr> <tr><td>2945</td><td>78.00</td><td>120.00</td></tr> </table> <p>3-1/4" Square</p> <table border="1"> <tr><th></th><th>Hemlock</th></tr> <tr><td>CNP-448</td><td>42.00</td></tr> </table>		Oak	Cherry	2940	\$66.00	\$100.00	2945	78.00	120.00		Hemlock	CNP-448	42.00	<p>3-1/4" Square</p> <table border="1"> <tr><th></th><th>Hemlock</th></tr> <tr><td>TNP-448</td><td>\$42.00</td></tr> <tr><td>TNP-460</td><td>52.00</td></tr> </table>		Hemlock	TNP-448	\$42.00	TNP-460	52.00	<p>3-1/4" S4S Beveled Top</p> <table border="1"> <tr><th></th><th>Hemlock</th></tr> <tr><td>S4S-448BV</td><td>\$40.00</td></tr> </table>		Hemlock	S4S-448BV	\$40.00	<p>4 1/2" Square</p> <table border="1"> <tr><th></th><th>Oak</th></tr> <tr><td>4610</td><td>\$180.00</td></tr> <tr><td>4615</td><td>220.00</td></tr> </table>		Oak	4610	\$180.00	4615	220.00	<p>4 1/2" Square</p> <table border="1"> <tr><th></th><th>Oak</th></tr> <tr><td>4640</td><td>\$200.00</td></tr> <tr><td>4645</td><td>220.00</td></tr> </table>		Oak	4640	\$200.00	4645	220.00
	Oak	Cherry																																																			
2910	\$63.00	\$94.00																																																			
2915	75.00	120.00																																																			
	Hemlock																																																				
ANP-460	52.00																																																				
	Oak	Cherry																																																			
2940	\$66.00	\$100.00																																																			
2945	78.00	120.00																																																			
	Hemlock																																																				
CNP-448	42.00																																																				
	Hemlock																																																				
TNP-448	\$42.00																																																				
TNP-460	52.00																																																				
	Hemlock																																																				
S4S-448BV	\$40.00																																																				
	Oak																																																				
4610	\$180.00																																																				
4615	220.00																																																				
	Oak																																																				
4640	\$200.00																																																				
4645	220.00																																																				

RW STOCKED BOX NEWELS

*Large Box Newel Splitting Charge \$24.00

Custom Species Available on Quote

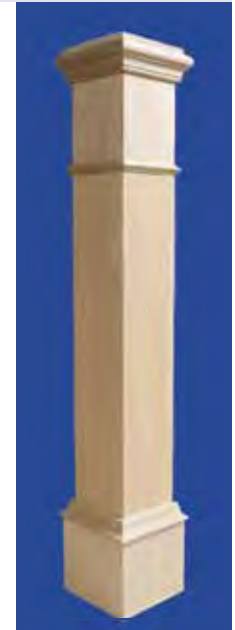
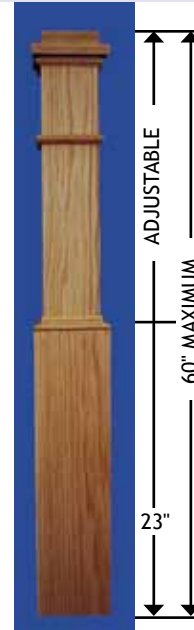
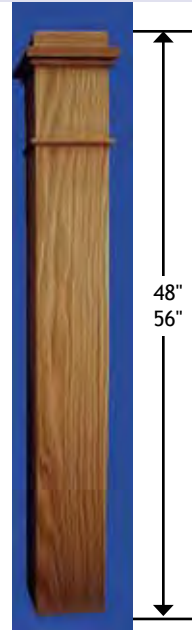
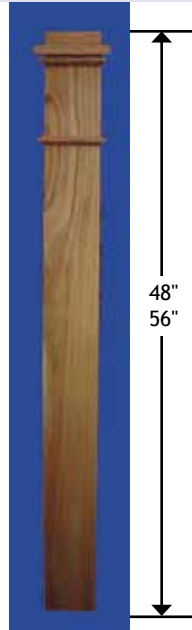
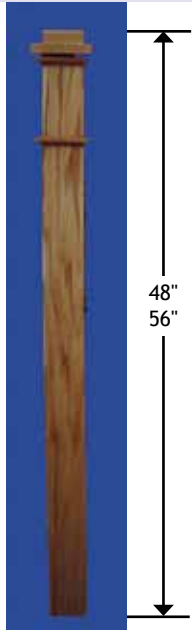

3 1/2" Square
4075 4076

Hemlock	\$90.00	\$120.00
Oak	100.00	130.00
Alder	110.00	140.00
Cherry	172.00	210.00

4 1/2" Square
4085 4086

Hemlock	\$140.00	\$180.00
Oak	160.00	200.00
Alder	180.00	220.00
Cherry	258.00	315.00

6" Square
4095 4096

Hemlock	\$210.00	\$230.00
Oak	220.00	250.00
Alder	230.00	260.00
Cherry	--	--

**4 1/2" Square Top
6" Bottom**
4091

Hemlock	\$220.00
Oak	230.00
Alder	240.00
Cherry	340.00

**MX456
3 1/2" X 56"**

Knotty Alder	\$160.00
Alder	160.00
Maple	180.00

**MX552
5" x 52"**

Knotty Alder	\$260.00
Alder	260.00
Maple	300.00

SPECIAL ORDER BOX NEWELS

Here are just a few samples of the many box newels available on special order. These newels are available in a variety of species. Please call for detailed information and current pricing.



IRON BALUSTERS

All Standard iron balusters are 44" length with "details" centered 18" from top. Cut as needed from the bottom. Standard balusters have 1/2" round domed tops for easy installation into handrail. Standard Square balusters are 1/2" x 1/2".

RW STOCKED - 1/2" Balusters

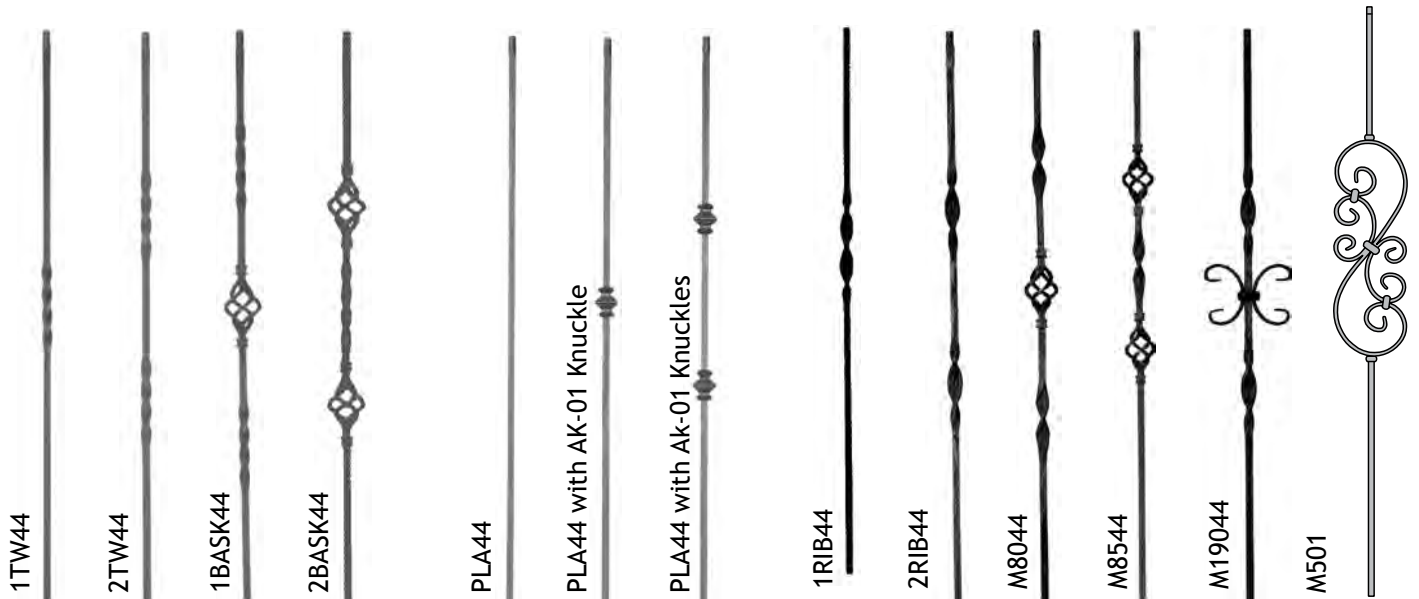

TWIST & BASKET

VERSATILE

RIBBON, BASKET & SCROLL

Available in 5 Finishes



ABZ
Antique Bronze
powder coated



B
Flat Black
lightly textured



PC
Grey Black
powder coated
1/2" Solid only



SAT
Satin Black
smooth finished



ORC
Oil Rubbed
Copper
powder coated

ECO - SERIES 1/2" ENGINEERED SQUARE TUBE

Square Tube	ABZ, B, SAT	ORC
ST 1 TW 44 - 1 Twist	\$5.28	\$6.38
ST 2 TW 44 - 2 Twist	5.72	6.82
ST 1 BASK 44 - 1 Basket	8.36	9.46
ST 2 BASK 44 - 2 Basket	10.78	11.88
ST PLA44 - Plain	5.06	6.16

Square Tube	SAT ONLY
ST 1 TW 44 - 1 Knuckle (Fixed)	\$8.36
ST 2 TW 44 - 2 Knuckle (Fixed)	10.78

1/2" SOLID IRON

	ABZ, B, PC, SAT	ORC
1 TW 44 - 1 Twist	\$7.70	\$8.80
2 TW 44 - 2 Twist	8.14	9.24
1 BASK 44 - 1 Basket	9.90	11.00
2 BASK 44 - 2 Basket	13.20	14.30
PLA44 - Plain	7.04	8.14
1RIB 44 - 1 Ribbon	8.80	10.45
2RIB 44 - 2 Ribbon	9.46	10.56
M8044 - 1 Basket Ribbon	13.20	14.85
M8544 - 2 Basket Ribbon	19.80	21.45
M19044 - Ribbon Butterfly	15.40	17.05
M501 - Scroll	22.00	23.60

KNUCKLES & SHOES

All Knuckles & Shoes are priced the same for all finishes.



AK-01
\$2.86



FSH-01
\$1.76



PSH-02
\$2.04



SCR-04
\$2.04



M-06
\$2.20
Tall Shoe
w/Set
Screw

IRON BALUSTERS - RW STOCKED - 9/16" (H-Series) & 3/4" Mega Series Square Tube

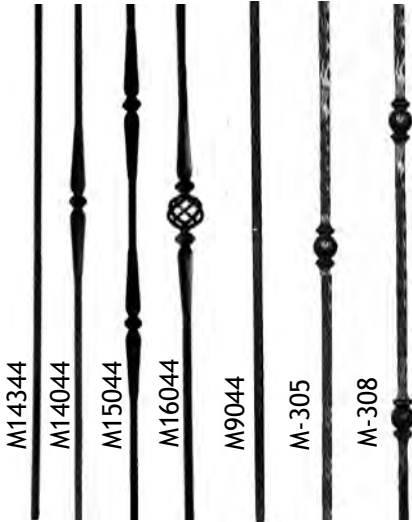

EPOXY ADHESIVE SYSTEM

FOR USE WITH ALL
IRON BALUSTERS

Item #	Description	Price
F501K	5.5oz. Adhesive Cartridge	\$31.00

Includes Small Mixing Nozzle & Caulk Gun
Adapter for standard caulking gun.
Fast drying - 5-7 min. cure
Installs approx 30-40 balusters,
anchoring both ends.

A24	Extra Nozzle for F501K	5.00
F110	Mixing Nozzle for F501K	3.30



GOthic

FORGED

ECO-MEGA

9/16" SOLID IRON

ABZ, B,

Item #	Description	SAT	ORC
M14344	Gothic	\$9.90	\$10.90
M14044	Gothic	12.65	13.65
M15044	Gothic	15.40	16.40
M16044	Gothic	19.80	20.80
M9044	Sante Fe Hammered	11.00	12.00
M30544	Forged	19.80	20.80
M30844	Forged	23.10	24.20

ECO-MEGA 3/4" SQUARE TUBE

Item #	Description	ORC
1KNUC44-M	1 Knuckle	\$15.50
2KNUC44-M	2 Knuckle	18.25
1TW44-M	1 Twist	9.90
2TW44-M	2 Twist	10.50
1BASK44-M	1 Basket	13.90
2BASK44-M	2 Basket	15.90
M08	3/4" Flat Shoe	3.00
PSH08	3/4" Pitch Shoe	3.00

9/16" H-SERIES KNUCKLES & SHOES

All Knuckles & Shoes
are priced the
same for all finishes.



H-03
\$2.04



H-05
\$2.20



H-06
\$2.20

Tall
Shoe
w/Set
Screw



H-04
\$2.20

All Knuckles & Shoes
are priced the
same for all finishes.

Special Order DECORATIVE PANELS

This is a small sample of
panels available. Please
call for full details on all
Decorative Panels available.

(Normally Less Than 1 Week Lead Time)

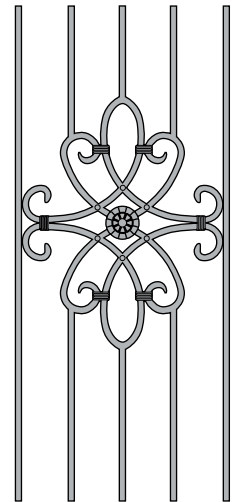
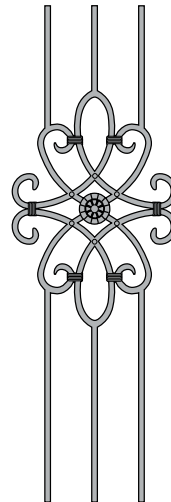
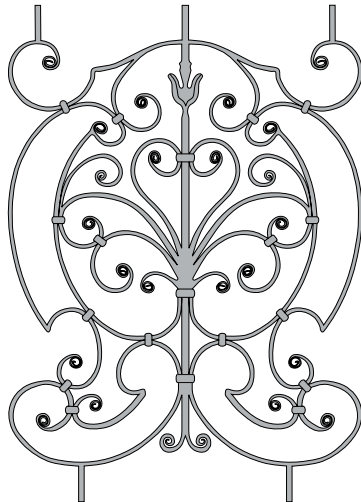

RW Stocked
Iron Balusters
on pages 5 & 6

SPECIAL ORDER IRON BALUSTERS AND NEWELS

Please call for current pricing and additional information.

All Balusters are 44" tall and Newels are 48" Tall.

This is just a sample of the many styles available.

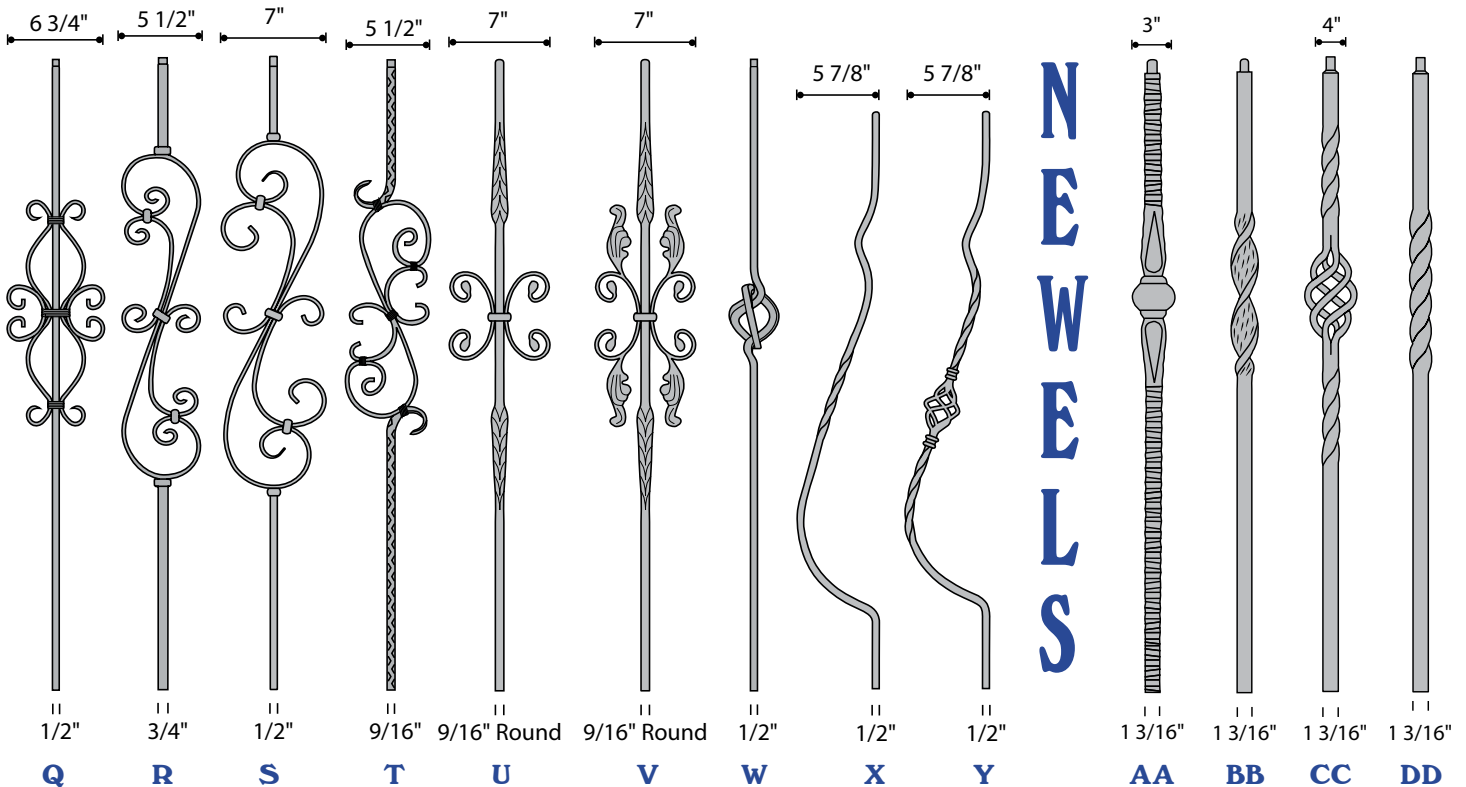
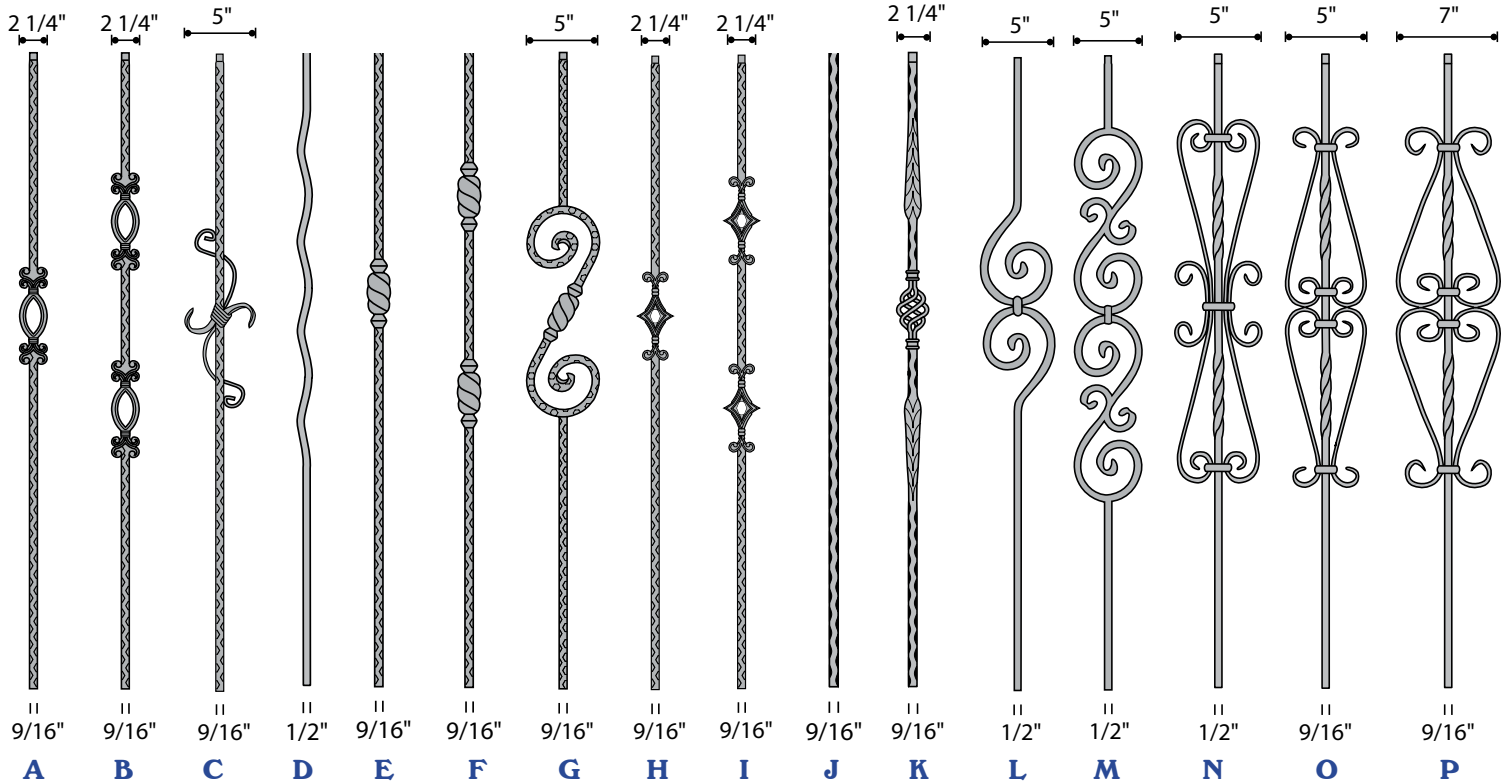

NEWELS

Balusters

For Exterior Balusters
see RW Dealer Catalog
Pages 26-40.

R/W Stocks ALL Balusters & Species Shown

Baluster Bottom Dowel Pins are 3/4" in Length and 3/4" Diameter.

<p>1-1/4" Square</p> <table border="1"> <thead> <tr> <th></th> <th>Oak</th> <th>Cherry</th> <th>Alder</th> </tr> </thead> <tbody> <tr><td>5015-31"</td><td>\$6.80</td><td>--</td><td>--</td></tr> <tr><td>5015-34"</td><td>7.35</td><td>9.60</td><td>--</td></tr> <tr><td>5015-36"</td><td>8.20</td><td>10.40</td><td>\$8.20</td></tr> <tr><td>5015-39"</td><td>8.70</td><td>10.90</td><td>8.70</td></tr> <tr><td>5015-41"</td><td>9.20</td><td>11.50</td><td>--</td></tr> <tr><td>5015-43"</td><td>9.80</td><td>12.20</td><td>9.80</td></tr> </tbody> </table> <p>1-1/4" Square</p> <table border="1"> <thead> <tr> <th></th> <th>Hemlock</th> </tr> </thead> <tbody> <tr><td>G-130</td><td>\$4.80</td></tr> <tr><td>G-133</td><td>5.00</td></tr> <tr><td>G-136</td><td>5.40</td></tr> <tr><td>G-139</td><td>5.90</td></tr> <tr><td>G-142</td><td>6.40</td></tr> </tbody> </table> <p>•No bottom dowel</p>		Oak	Cherry	Alder	5015-31"	\$6.80	--	--	5015-34"	7.35	9.60	--	5015-36"	8.20	10.40	\$8.20	5015-39"	8.70	10.90	8.70	5015-41"	9.20	11.50	--	5015-43"	9.80	12.20	9.80		Hemlock	G-130	\$4.80	G-133	5.00	G-136	5.40	G-139	5.90	G-142	6.40	<p>1-1/4" Square</p> <table border="1"> <thead> <tr> <th></th> <th>Oak</th> </tr> </thead> <tbody> <tr><td>•5141-36"</td><td>\$8.20</td></tr> <tr><td>•5141-42"</td><td>9.60</td></tr> </tbody> </table> <p>1-1/4" Square</p> <table border="1"> <thead> <tr> <th></th> <th>Hemlock</th> </tr> </thead> <tbody> <tr><td>E-136</td><td>\$5.60</td></tr> <tr><td>E-143</td><td>6.80</td></tr> </tbody> </table> <p>•No bottom dowel</p>		Oak	•5141-36"	\$8.20	•5141-42"	9.60		Hemlock	E-136	\$5.60	E-143	6.80	<p>1-1/4" Square</p> <table border="1"> <thead> <tr> <th></th> <th>Oak</th> <th>HEM</th> </tr> </thead> <tbody> <tr><td>5200-36"</td><td>\$8.20</td><td>5.60</td></tr> <tr><td>5200-39"</td><td>8.70</td><td>8.70</td></tr> <tr><td>•5200-44"LB</td><td>9.80</td><td>9.80</td></tr> </tbody> </table> <p>1-1/4" Square</p> <table border="1"> <thead> <tr> <th></th> <th>Hemlock</th> </tr> </thead> <tbody> <tr><td>STT-134</td><td>\$5.30</td></tr> <tr><td>STT-137</td><td>5.60</td></tr> <tr><td>STT-140</td><td>6.20</td></tr> <tr><td>STT-143</td><td>6.80</td></tr> </tbody> </table> <p>•No bottom dowel</p>		Oak	HEM	5200-36"	\$8.20	5.60	5200-39"	8.70	8.70	•5200-44"LB	9.80	9.80		Hemlock	STT-134	\$5.30	STT-137	5.60	STT-140	6.20	STT-143	6.80	<p>1-3/4" Square</p> <table border="1"> <thead> <tr> <th></th> <th>Oak</th> <th>HEM</th> </tr> </thead> <tbody> <tr><td>5300-36"</td><td>13.40</td><td>15.00</td></tr> <tr><td>•5300-42"LB</td><td>15.00</td><td>15.00</td></tr> </tbody> </table> <p>1-5/8" Square</p> <table border="1"> <thead> <tr> <th></th> <th>Hemlock</th> </tr> </thead> <tbody> <tr><td>•STT-236</td><td>\$7.60</td></tr> <tr><td>•STT-242</td><td>8.60</td></tr> </tbody> </table> <p>•No bottom dowel</p>		Oak	HEM	5300-36"	13.40	15.00	•5300-42"LB	15.00	15.00		Hemlock	•STT-236	\$7.60	•STT-242	8.60	<p>2-1/4" Square</p> <table border="1"> <thead> <tr> <th></th> <th>Oak</th> </tr> </thead> <tbody> <tr><td>•5712-36"</td><td>23.60</td></tr> <tr><td>•5712-42"</td><td>27.10</td></tr> </tbody> </table> <p>•No bottom dowel</p>		Oak	•5712-36"	23.60	•5712-42"	27.10
	Oak	Cherry	Alder																																																																																																
5015-31"	\$6.80	--	--																																																																																																
5015-34"	7.35	9.60	--																																																																																																
5015-36"	8.20	10.40	\$8.20																																																																																																
5015-39"	8.70	10.90	8.70																																																																																																
5015-41"	9.20	11.50	--																																																																																																
5015-43"	9.80	12.20	9.80																																																																																																
	Hemlock																																																																																																		
G-130	\$4.80																																																																																																		
G-133	5.00																																																																																																		
G-136	5.40																																																																																																		
G-139	5.90																																																																																																		
G-142	6.40																																																																																																		
	Oak																																																																																																		
•5141-36"	\$8.20																																																																																																		
•5141-42"	9.60																																																																																																		
	Hemlock																																																																																																		
E-136	\$5.60																																																																																																		
E-143	6.80																																																																																																		
	Oak	HEM																																																																																																	
5200-36"	\$8.20	5.60																																																																																																	
5200-39"	8.70	8.70																																																																																																	
•5200-44"LB	9.80	9.80																																																																																																	
	Hemlock																																																																																																		
STT-134	\$5.30																																																																																																		
STT-137	5.60																																																																																																		
STT-140	6.20																																																																																																		
STT-143	6.80																																																																																																		
	Oak	HEM																																																																																																	
5300-36"	13.40	15.00																																																																																																	
•5300-42"LB	15.00	15.00																																																																																																	
	Hemlock																																																																																																		
•STT-236	\$7.60																																																																																																		
•STT-242	8.60																																																																																																		
	Oak																																																																																																		
•5712-36"	23.60																																																																																																		
•5712-42"	27.10																																																																																																		

S4S Baluster Blanks Shown On Page 14.

(LB means LONG BOTTOM SQUARE)

<p>1-1/4" Square</p> <table border="1"> <thead> <tr> <th></th> <th>Oak/Maple</th> <th>Alder</th> </tr> </thead> <tbody> <tr><td>•2215-36"</td><td>\$8.20</td><td>\$8.20</td></tr> <tr><td>•2215-42"</td><td>9.60</td><td>9.60</td></tr> </tbody> </table> <p>•No bottom dowel</p>		Oak/Maple	Alder	•2215-36"	\$8.20	\$8.20	•2215-42"	9.60	9.60	<p>1-1/4" Square</p> <table border="1"> <thead> <tr> <th></th> <th>Oak/Maple</th> <th>Alder</th> </tr> </thead> <tbody> <tr><td>•2200-36"</td><td>\$8.20</td><td>\$8.20</td></tr> <tr><td>•2200-42"</td><td>9.60</td><td>9.60</td></tr> </tbody> </table> <p>•No bottom dowel</p>		Oak/Maple	Alder	•2200-36"	\$8.20	\$8.20	•2200-42"	9.60	9.60	<p>1-3/4" Square</p> <table border="1"> <thead> <tr> <th></th> <th>Oak/Maple</th> <th>Alder</th> </tr> </thead> <tbody> <tr><td>•2315-36"</td><td>\$13.40</td><td>\$14.20</td></tr> <tr><td>•2315-42"</td><td>15.00</td><td>16.00</td></tr> </tbody> </table> <p>•No bottom dowel</p>		Oak/Maple	Alder	•2315-36"	\$13.40	\$14.20	•2315-42"	15.00	16.00	<p>1-3/4" Square</p> <table border="1"> <thead> <tr> <th></th> <th>Oak/Maple</th> <th>Alder</th> </tr> </thead> <tbody> <tr><td>•2300-36"</td><td>\$13.40</td><td>\$14.20</td></tr> <tr><td>•2300-42"</td><td>15.00</td><td>16.00</td></tr> </tbody> </table> <p>•No bottom dowel</p>		Oak/Maple	Alder	•2300-36"	\$13.40	\$14.20	•2300-42"	15.00	16.00	<p>1-3/4" Square</p> <table border="1"> <thead> <tr> <th></th> <th>Oak</th> <th>Cherry</th> </tr> </thead> <tbody> <tr><td>2015-36"</td><td>\$13.40</td><td>\$17.20</td></tr> <tr><td>•2015-42"</td><td>15.00</td><td>19.40</td></tr> </tbody> </table> <p>3-1/4" Square</p> <table border="1"> <thead> <tr> <th></th> <th>Hemlock</th> </tr> </thead> <tbody> <tr><td>F-242</td><td>8.60</td></tr> </tbody> </table> <p>•No bottom dowel</p>		Oak	Cherry	2015-36"	\$13.40	\$17.20	•2015-42"	15.00	19.40		Hemlock	F-242	8.60
	Oak/Maple	Alder																																																			
•2215-36"	\$8.20	\$8.20																																																			
•2215-42"	9.60	9.60																																																			
	Oak/Maple	Alder																																																			
•2200-36"	\$8.20	\$8.20																																																			
•2200-42"	9.60	9.60																																																			
	Oak/Maple	Alder																																																			
•2315-36"	\$13.40	\$14.20																																																			
•2315-42"	15.00	16.00																																																			
	Oak/Maple	Alder																																																			
•2300-36"	\$13.40	\$14.20																																																			
•2300-42"	15.00	16.00																																																			
	Oak	Cherry																																																			
2015-36"	\$13.40	\$17.20																																																			
•2015-42"	15.00	19.40																																																			
	Hemlock																																																				
F-242	8.60																																																				

Fluting or Twisting of Balusters Available.

Balusters



<p>1-1/4" Square</p> <ul style="list-style-type: none"> •5105-36" Oak \$8.20 •5105-44" Hemlock 9.80 <p>1-1/4" Square</p> <ul style="list-style-type: none"> •S-137 Hemlock \$5.60 •S-143 Hemlock 6.80 <p>•No bottom dowel</p>	<p>1-3/4" Square</p> <ul style="list-style-type: none"> •5005-36" Oak \$13.40 •5005-42" Oak 15.00 <p>1-5/8" Square</p> <ul style="list-style-type: none"> •S-232 Hemlock \$7.20 •S-236 Hemlock 7.60 •S-242 Hemlock 8.60 <p>•No bottom dowel</p>	<p>2-1/4" Square</p> <ul style="list-style-type: none"> •5702-36" Oak \$23.60 •5702-42" Oak 27.10 <p>•No bottom dowel</p>	<p>1-1/4" Square</p> <ul style="list-style-type: none"> 5067-34" Oak \$8.00 5067-36" Oak 8.20 5067-39" Oak 8.70 5067-41" Oak 9.20 <p>1-1/4" Square</p> <ul style="list-style-type: none"> K-131 Hemlock 4.80 K-134 Hemlock 5.30 K-137 Hemlock 5.60 K-140 Hemlock 6.20 K-143 Hemlock 6.80 <p>•No bottom dowel</p>	<p>NOT AVAILABLE IN OAK</p> <p>1-5/8" Square</p> <ul style="list-style-type: none"> •T-232 Hemlock \$7.20 •T-236 Hemlock 7.60 •T-242 Hemlock 8.60 <p>•No bottom dowel</p>

Most Balusters are Available in Other Species. Please Call for Availability.

Painted Balusters & Baluster Panel

<p>1-1/4" Square</p> <ul style="list-style-type: none"> 5141-36PR \$5.60 5141-42PR 6.50 S4S-136PR 5.60 S4S-142PR 6.50 	<p>1-1/4" Square</p> <ul style="list-style-type: none"> 5015-31PR \$5.00 5015-34PR 5.40 5015-36PR 5.60 5015-39PR 6.00 5015-41PR 6.20 5015-43PR 6.50 	<p>1-3/4" Square</p> <ul style="list-style-type: none"> 2015-36PR \$8.80 2015-42PR 9.80 2315-36PR 8.80 2315-42PR 9.80 	<p>1-3/4" Square</p> <ul style="list-style-type: none"> 5005-36PR" \$8.80 5005-42PR" 9.80 	<p>Painted Baluster Panel 1-3/4" x 6-1/2" x 42"</p> <p>BP3/R-42PR \$35.00</p>

Rails, Shoes & Fillets

1J = 1 JOINT ALLOWED ON TOP LAMINATION

ST = SOLID TOP
SS = SOLID (All Lams)

S = SOLID (No Lams)
FJ = F/J (All Lams)

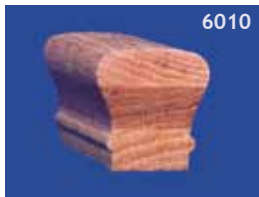

6010
2-1/4"W x 2-3/8"H 1-1/2" Bottom
FJ Oak \$6.90
1J Oak \$7.60 1J Cherry \$16.50
ST Oak 8.00 1J Maple 9.00
SS Oak 10.00 2J Alder 9.00



6210
2-7/8"W x 2-3/8"H 2-1/8" Bottom
1J Oak \$11.20
1J Cherry 28.00
1J Maple 12.00
2J Alder 12.00



6100
2"W x 2-5/8"H
2" Bottom
SS Oak \$12.00

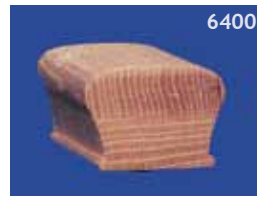

6400
2-3/4"W x 2"H
2-1/4" Bottom
SS Oak \$12.00



6500
2-3/4"W x 2"H
2-1/4" Bottom
SS Oak \$12.00

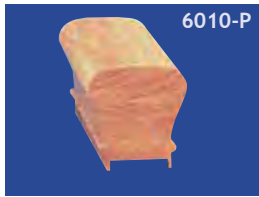

6010-P
2-1/4"W x 2-3/8"H
(1-1/4" Plow)
1J Oak \$7.60
ST Oak 8.00
2J Alder 9.50



8110
2-5/8"W x 2-1/4"H
2-1/4" Bottom
1J Oak \$10.50
1J Maple 12.50
2J Alder 12.50



6116
Oak \$17.00



6610
2-3/4"W x 2-1/8"H
1-5/8" Bottom
1J Oak \$ 11.20
1J Maple 12.00
1J Cherry 22.00
1J Alder 12.00

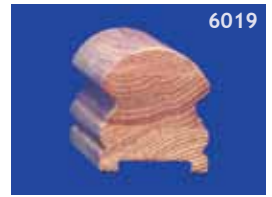

6019
2-9/16"W x 3"H
1-3/4" Plow
1J Oak \$14.50



6016
Oak \$17.00
Maple 19.00
Cherry 26.00
Alder 18.00



6216
Oak \$24.00
Maple 24.00
Cherry 34.00
Alder 24.00

ALL ST RAILS 15' & 16'
ARE EXTREMELY
HARD TO GET!
PLEASE ORDER
TRUE JOB LENGTHS.
BEAD & GROOVE RAILS
ARE DESIGNED FOR A
MINIMUM BENDING
RADIUS OF 5'0".



6616
Oak \$20.00
Maple 22.00
Cherry 28.00
Alder 20.00



6005
2-9/16"W x 2-3/8"H
1-3/4" Plow
1J Oak \$11.20



6016BA
Oak \$20.50



6216BA
Oak \$26.00



6040
1-3/4"W x 1-5/8"H 7/8" Bottom
Oak \$5.50



6042
2-1/4"W x 1-1/4"H
1-1/8" Bottom
Oak \$5.50



6050 Fillet 3/8" x 1-1/4" \$1.40
6060 Fillet 3/8" x 1/1/4" \$1.20
6045 Shoe 3/4" x 2/1/2" (1-1/4" plow) \$3.00
S Oak 1.60
S Maple 2.00
S Cherry 1.40
Alder 1.40



6007 Fillet 3/8" x 1-3/4" \$1.80
6006 Shoe 1" x 3-1/8" (1-3/4" plow) \$4.70
S Oak 2.00
S Maple 2.80
S Cherry 1.80
Alder 1.80



6007 Fillet 3/8" x 1-3/4" \$1.80
6046 Shoe 3/4" x 2-5/8" (1-3/4" plow) \$3.50
S Oak 2.00
S Maple 2.80
S Cherry 1.80
Alder 1.80



6012
2"W x 1-3/4"H
1-1/2" Bottom
S Oak \$6.60

OUTSIDE BENDING PROFILE INCLUDED
WITH ALL BENDING RAIL.

ALL "BA" BENDING RAILS REQUIRE
BEND AID BRACKETS.
SEE PAGE 16.

CUSTOM PLOWING OF ANY
HARDWOOD OR HEMLOCK
ADD .35¢ PER LINEAL FOOT (\$17.50 MIN.).

FILLET WILL BE AUTOMATICALLY
ADDED AND CHARGED TO YOUR ORDER.

HEMLOCK

Rails, Shoes & Fillets

1J = 1 JOINT ALLOWED ON TOP LAMINATION

ST = SOLID TOP
SS = SOLID (All Lams)

S = SOLID (No Lams)
FJ = F/J (All Lams)

HC = CORE Solid 3S
HCF = CORE 1J3S

RAIL DIMENSIONS CAN VARY $\pm 1/16"$
(PLOW WILL NOT VARY)



6010H (G)
2-1/4"W x 2-3/8"H
1-9/16" Bottom
ST Hemlock \$5.50
SS Hemlock 6.25
HC 5.75



6210H (G2)
2-7/8"W x 2-3/8"H
2-1/4" Bottom
ST \$7.20



6910-HP
2"-1/4W x 1-7/8"H
1-5/8" Bottom
(1-1/4" Plow)
ST Hemlock \$5.70



6910-H
2"-1/4W x 1-7/8"H
1-5/8" Bottom
ST Hemlock \$5.50



6610-H
2"-11/16"W x 2-1/8"H
1-5/8" Bottom
ST Hemlock \$6.50



6010-HP
2-1/4"W x 2-3/8"H
1-9/16" Bottom 1-1/4" Plow
ST Plowed \$5.90
SS Plowed 6.65
HC Plowed 6.15
(G-E Fillet included in this price)



\$15.00



MTN (6100)
2"W x 2-5/8"H
2" Bottom
ST 5.70



\$15.00



6710-HS
2-1/4"W x 2-1/4"H
1-1/2" Bottom
SS Hemlock \$6.75



6016-H7 \$13.60

CUSTOM PLOWING
OF ANY
HARDWOOD OR
HEMLOCK RAIL
ADD .35¢ PER LINEAL
FOOT (\$17.⁵⁰ MIN.).
FILLET WILL BE
AUTOMATICALLY
ADDED TO
YOUR ORDER.



26WG
1-5/16" x 5-1/4"
\$6.00
(Laminated)



S
2-1/4"W x 2-3/8"H
1-5/8" Plow
ST \$5.80



\$15.00



\$16.00



M-C G-E G-S
3/8"x1-1/4" M-C Fillet-S \$.60
5/16"x1-1/4" G-E Fillet-S .40
1-1/8"x2-1/2" G-S Shoe
1-1/4" Plow 1.75
Solid 2.50



C F E SS
7/16"x1-5-8" C Fillet-S \$.70
5/16"x1-5/8" E Fillet-S .45
1-1/8"x2-1/2" SS Shoe
1-5/8" Plow 1.75



M-C G-E MTN-G
3/8"x1-1/4" M-C Fillet-S \$.60
5/16"x1-1/4" G-E Fillet-S .40
3/4"x2-3/8" MTN-G Shoe
1-1/4" Plow 1.65



WALL RAIL



COL-W
2"W x 2"H
1-1/2" Bottom
ST \$4.75



V
2-1/4"W x 1-1/4"H
1-1/8" Bottom
ST \$2.75

Handrail Returns
Are Accepted
Only in Lengths
of 8' and Longer.

OUTSIDE BENDING PROFILE INCLUDED
WITH ALL BENDING RAIL.

ALL "BA" BENDING RAILS REQUIRE
BEND AID BRACKETS.
SEE PAGE 16.



Stair Fittings

R/W Denver Stocks All Stair Fittings
Listed as "RW Stocked".
Fittings Listed as "Custom"
are Made in R/W's Mill &
Require 7-10 Working Days Lead Time.

Fittings Are Made
To Match The
Rails Below.
Other Wood Species
Available On Quote.

Fittings Match Rails Shown	RW STOCKED 6010 Hemlock	RW STOCKED 6010 R. Oak 6010 Alder	RW STOCKED 6010 Maple	RW STOCKED 6210 R. Oak 6610 R. Oak 6610 Maple 6610 Alder	RW STOCKED 6010 Cherry	RW STOCKED 6610 Cherry
Style Code	1	2	3	4	5	6
09	\$ 10.00	\$ 10.00	\$ 24.00	\$ 24.00	\$ 24.00	\$ 36.00
10	39.00	42.00	52.00	60.00	81.00	90.00
11	27.00	32.00	39.00	46.00	60.00	66.00
11-135°	42.00	42.00	49.00	56.00	72.00	76.00
12	25.00	31.00	38.00	45.00	53.00	58.00
13	27.00	32.00	40.00	44.00	58.00	65.00
14	28.00	34.00	42.00	49.00	58.00	65.00
19	16.00	18.00	28.00	30.00	36.00	40.00
20	24.00	26.00	36.00	39.00	52.00	56.00
21	30.00	35.00	46.00	50.00	73.00	77.00
21-135°	42.00	45.00	52.00	60.00	99.00	112.00
22 L/R	42.00	46.00	58.00	65.00	105.00	120.00
25 L/R	77.00	88.00	102.00	116.00	138.00	148.00
26 L/R	79.00	90.00	104.00	118.00	140.00	151.00
27	84.00	88.00	110.00*	120.00*	160.00*	175.00*
30	90.00	110.00	138.00	160.00	175.00	204.00
35	90.00	110.00	138.00	160.00	175.00	204.00
30-SR (Custom)	N/A	160.00	QUOTE	QUOTE	QUOTE	QUOTE
35-SR (Custom)	N/A	160.00	QUOTE	QUOTE	QUOTE	QUOTE
40	56.00	62.00	86.00	95.00	128.00	136.00
41	56.00	62.00	86.00	95.00	128.00	136.00
45	56.00	62.00	86.00	95.00	128.00	136.00
46	56.00	62.00	86.00	95.00	128.00	136.00
50	96.00	99.00	128.00	148.00	207.00	220.00
55	96.00	99.00	128.00	148.00	207.00	220.00
60	100.00	103.00	131.00	156.00	219.00	240.00
65	100.00	103.00	131.00	156.00	219.00	240.00
70-71	70.00	72.00	93.00	107.00	166.00	175.00
75-76	70.00	72.00	93.00	107.00	166.00	175.00
80-81	76.00	80.00	97.00	116.00	173.00	182.00
85-86	76.00	80.00	97.00	116.00	173.00	182.00
88-89	68.00	70.00	81.00	97.00	145.00	152.00
90-2	78.00	86.00	110.00	131.00	140.00	150.00
95-2	78.00	86.00	110.00	131.00	140.00	150.00
90WC-2	84.00	92.00	115.00	135.00	145.00	155.00
95WC-2	84.00	92.00	115.00	135.00	145.00	155.00
96-97	58.00	60.00	72.00	87.00	100.00	110.00
98-99	50.00	52.00	68.00	78.00	129.00	138.00

6010

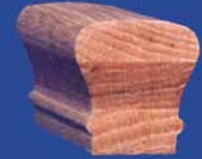

6210



6100 (MTN)



6400



6500



6610



R/W has a
VERY CREATIVE
Woodworking Team!

SPECIAL FITTING STYLES ARE MADE IN OUR MILL
SEE PAGE 14. OTHER WOODS AVAILABLE ON QUOTE.
CALL US FOR CUSTOM MILLWORK!



All Fittings are Carton-Packed & Include Full Instructions, Templates, Rail Bolts & 1" Tapered Plugs.



Fittings with Style Codes:

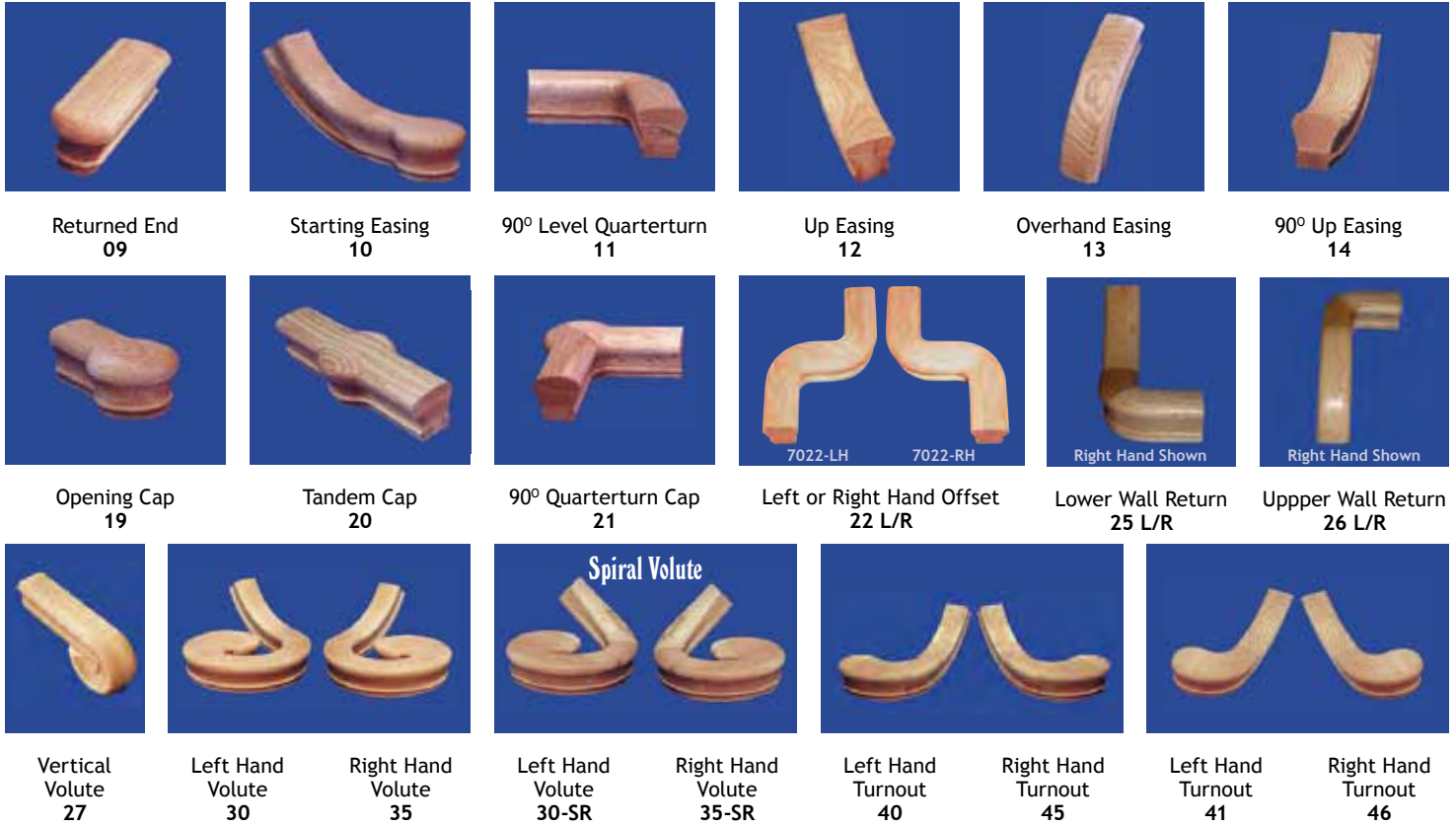

GOOSENECK FITTINGS HAVE UNATTACHED BOTTOM #12 UP EASING AND EXTRA LONG RAIL DROPS FOR EASY "ON THE JOB" ADJUSTMENT OF RAIL HEIGHTS.

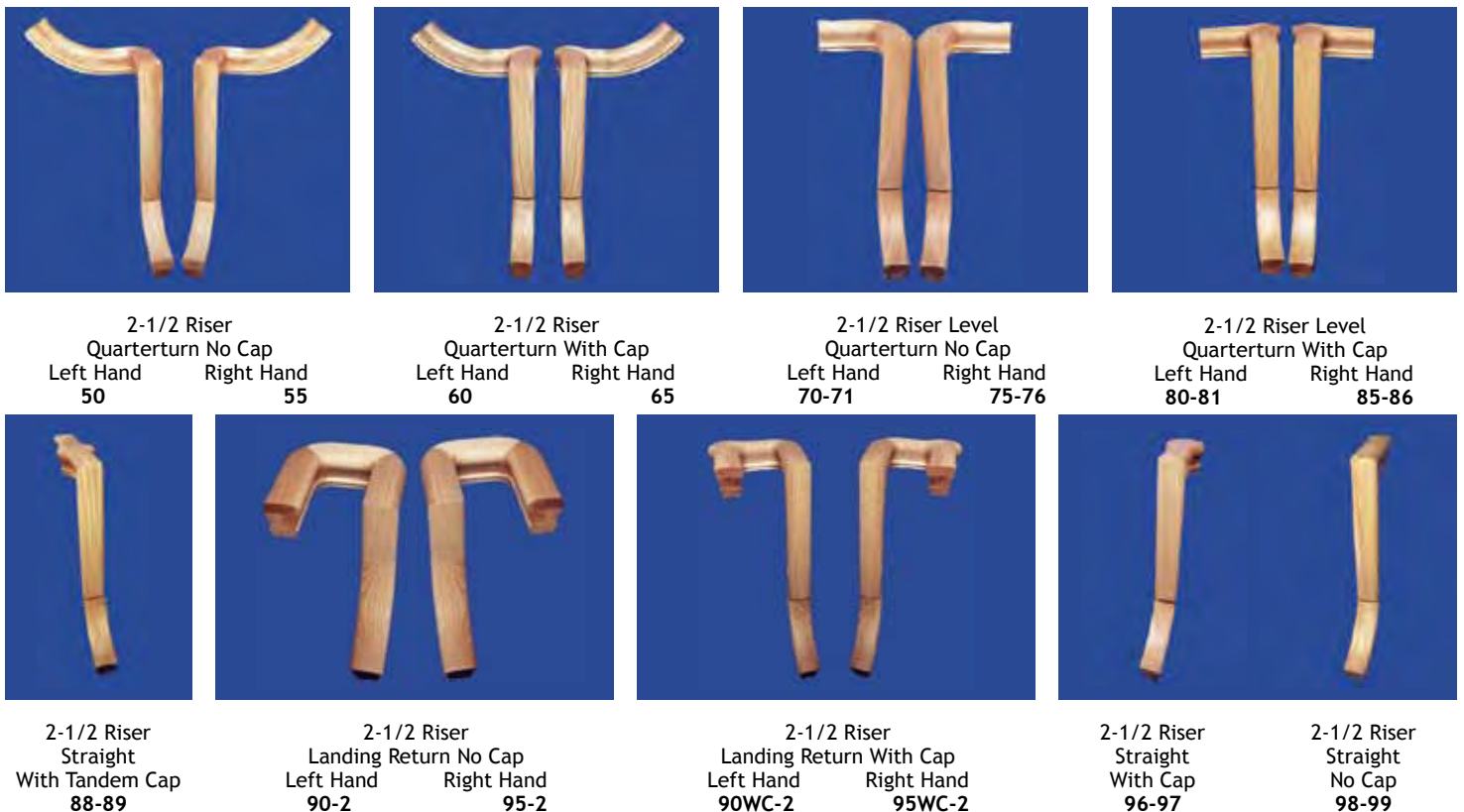

RW Stocked S4S and EE Squares & Boards

No Finger Joint - Clear

HARDWOODS

HEMLOCK

Squares

	Red Oak	S. Maple	Poplar	Cherry	Alder
#5060					
1-1/4" x 31"	--	\$ 5.50	\$ --	\$ --	\$ --
1-1/4" x 34"	\$6.00	5.80	--	--	--
1-1/4" x 36"	6.40	6.40	--	9.50	6.40
1-1/4" x 41"	7.30	6.95	--	10.50	7.40
1-1/4" x 44"	8.00	7.30	--	--	--
#5061					
1-3/4" x 36"	11.50	11.50	6.80	--	12.80
1-3/4" x 42"	13.40	13.40	7.90	--	14.60
3" x 48"	57.00	--	--	96.00	--
3" x 54"	64.00	--	--	--	72.00
3-1/2" x 48"	74.00	--	--	--	82.00
3-1/2" x 54"	--	--	--	--	90.00
3-1/2" x 56"	88.00	82.00	--	--	--
3-1/2" x 96"	207.00	--	--	--	--
4-1/2" x 48"	158.00	--	--	--	--
4-1/2" x 56"	184.00	--	--	--	--

Boards

	Red Oak	Maple	Poplar	Alder	Knotty Alder
1 x 6					
1 x 8					
1 x 12					

Squares

	Hemlock
1-1/4" x 31"	\$ 2.30
1-1/4" x 34"	2.65
1-1/4" x 37"	3.04
1-1/4" x 39"	3.20
1-1/4" x 43"	3.50
1-1/4" x 48"	4.10
1-5/8" x 24"	2.50
1-5/8" x 36"	4.72
1-5/8" x 48"	5.80
3-1/4" x 48"	28.40
3-1/4" x 60"	36.80
3-1/4" x 96"	75.00

EASED EDGE

Squares

	Hemlock
1-1/4" x 36"	2.90
1-1/4" x 42"	3.40
1-7/16" x 42"	3.60
1-7/16" x 48"	4.00



CALL FOR CURRENT PRICING

Level Radius Quarter Circles Machined to Match R/W Rails



Note: Half circles are priced as 2-quarter circles.

Quarter or half circles can be made with straight rail on either or both ends on quote!

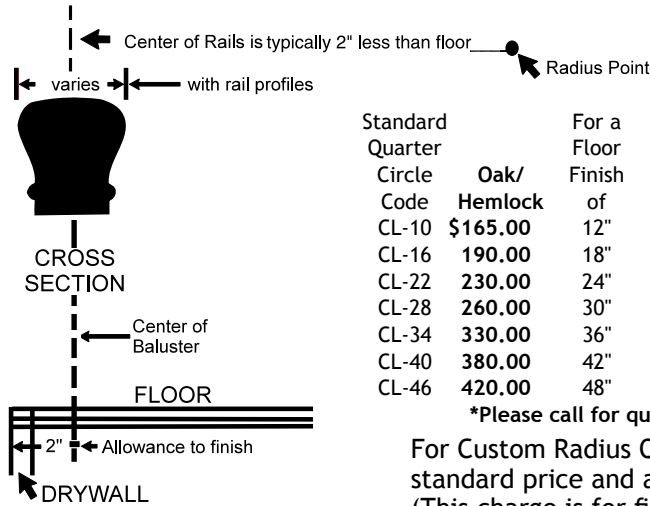

Standard Quarter Circle Code	Oak/ Hemlock	For a Floor Finish	The Center of Rails will be	OUTSIDE OF RAIL WILL BE
CL-10	\$165.00	12"	10"	6010 or G 6210
CL-16	190.00	18"	16"	6400 or G 6610
CL-22	230.00	24"	22"	6400 or G 6610
CL-28	260.00	30"	28"	6400 or G 6610
CL-34	330.00	36"	34"	6400 or G 6610
CL-40	380.00	42"	40"	6400 or G 6610
CL-46	420.00	48"	46"	6400 or G 6610

*Please call for quote on other wood species.

For Custom Radius Quarter Circles use next larger standard price and add \$150.00 for template. (This charge is for first quarter circle only.)

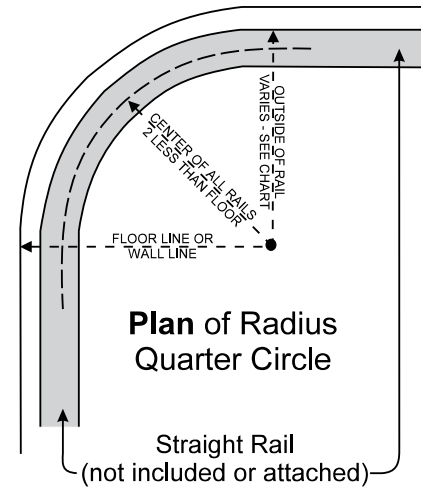

We have a VERY CREATIVE Woodworking Team! Here Are A Few Samples From Our Mill:



Starting Steps, Treads, Risers, Mouldings & Tread Covers



Single end starting steps are either right or left hand. Please specify. Add 5% for reversible.

Starting steps made to order - please check time.



NOTE: Add to all starting steps - \$32.00 for each 12" over the 48" shown. Radius end cove and/or shoe optional at \$36.00 per each cove or shoe (includes straight piece).

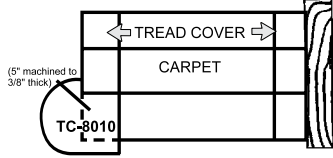

TC-8010-5" \$140.00
Designed for use on stairs with volutes or turnouts, using tread covers. 5" machined to 3/8" thick. Radius end cove included.

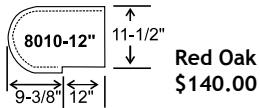

Red Oak \$140.00

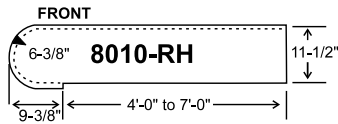

Red Oak 48" \$195.00

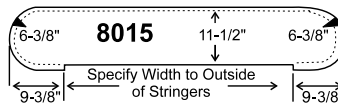

Red Oak 48" \$280.00

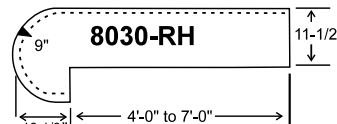

Red Oak 48" \$260.00

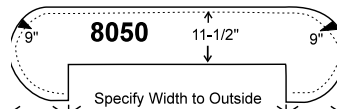

Red Oak 48" \$340.00

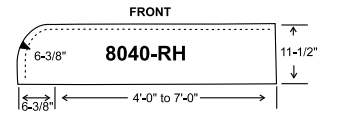

Red Oak 48" \$220.00

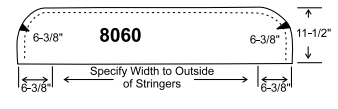

Red Oak 48" \$270.00

NOSING



1-1/16" x 1-1/4" \$2.20
8080-A \$2.60
HN - \$1.30 (Hemlock)

COVE



3/4" x 3/4" \$1.20

SHOE



5/8" x 3/4" \$0.96

DECORATIVE BRACKETS



5/16" x 7-5/8" x 11-1/2" \$9.00



5/16" x 8-1/4" x 11-1/2" \$8.00

LANDING TREAD



1-1/16" X 3-1/2" \$4.90
8090-RO HLT \$3.50 (Hemlock)

1-1/16" x 5-1/4" \$8.40
8090-5 RO

TREAD COVERS

Solid Panel 3/8" Thick; Nosing 1" x 1-3/8"; Cove 3/4" x 3/4".

Can be job cut right or left hand (left shown).

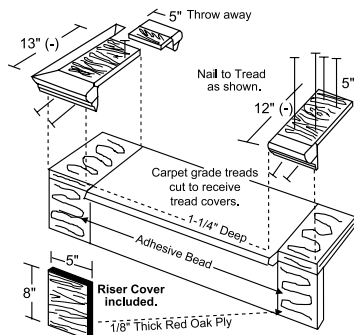

Tread Cover Wall End

Code TRC-WE
Red Oak \$14.50
Maple 19.00
Alder 22.00
Cherry 26.00

Tread Cover Open End

Miter Return
Code TRC-OE
Red Oak \$20.00
Maple 29.00
Alder 30.00
Cherry 34.00

Riser Cover Also Sold Separately \$4.00

(Cove Moulding unattached)

www.rwspecialties.com

TREADS & RISERS



1-1/16" x 11-1/2" \$41.70
8070 PLAIN TREAD

3/4" x 7-1/4" \$19.00
8075-RO RISER

	Red Oak	Hemlock	Red Oak
36"	\$ 41.70	\$ 24.00	\$19.00
42"	48.65	27.00	22.00
48"	55.60	30.00	26.00
60"	69.50	38.00	32.00
72"	83.40	--	40.00
96"	120.00	--	

Hemlock Treads are Finger Jointed

MITERED RETURN TREAD
ADD \$30.00
TO PLAIN TREADS

Custom Sizes & Species Available on Quote.

Stair Accessories



Brackets and Clamps for Bending Rail!

Heavy Duty Steel Leveling & Forming Brackets.

BALB-B	BEND-AID Leveling Bracket	4.50
	Type B for 2-3/8" High Rail	
BAFB	BEND-AID Forming Bracket	16.00
BA-C	"C" Clamps - 5" Heavy Duty	16.00

Patent No. 4,960,137

Wall Rail Brackets

Note: All Finishes Not Shown



3003 - \$6.50



3002
Antique Brass \$2.70
Brass Plated 2.70
Brushed Nickel 2.70
Oil Rub. Brz. 2.70

ABZ	Antique Bronze	C	Chrome
AN	Anitque Nickel	ORB	Oil Rubbed Bronze
B	Black	ORC	Oil Rubbed Copper
BP	Brass Plated	PC	Powder Coated
BN	Brushed Nickel	SAT	Satin Black



310
Solid Brass \$21.62

NEWEL ATTACHING HARDWARE The Original Newel / Post Anchor System

NAH-ALDER	\$ 16.00	NAHM-A	Moulding only	\$ 2.40 LF
NAH-CHERRY	17.00	NAHM-CH	Moulding only	3.00 LF
NAH-HEMLOCK	15.00	NAHM-HEM	Moulding only	1.20 LF
NAH-MAPLE	16.00	NAHM-M	Moulding only	2.50 LF
NAH-OAK	15.50	NAHM-RO	Moulding only	1.80 LF

NB Bracket only with Screws 2.00 EA

Other species wood trim on order & quote.

Patent #4,381,160

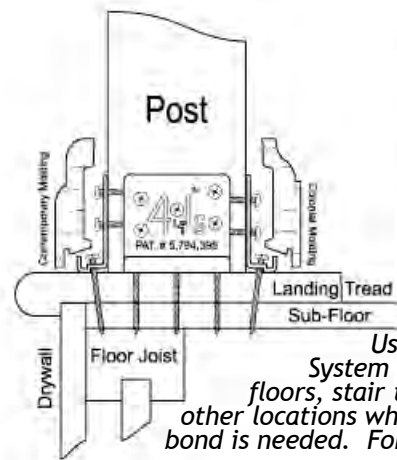

4J's™
Post
Mounting
System™
PAT. # 5,794,395

Use the 4J's Post Mounting System to mount newel posts to floors, stair treads, landing treads or other locations where a strong, permanent bond is needed. For interior or exterior use

CONTEMPORARY			
For 3" Posts		For 3-1/2" Posts	
4J-3RO	Oak \$18.90	4J-35RO	Oak \$19.40
4J-3A	Alder 18.90	4J-35A	Alder 19.40
4J-3M	Maple 18.90	4J-35M	Maple 19.40
		4J-35S	Softwood 18.90

CONTEMPORARY MOULDING ONLY			
4J-ROM	Oak 4.80LF	4J-MAM	Maple 4.80LF
4J-AM	Alder 4.80LF	4J-SM	Softwood 4.48LF

COLONIAL			
4J-35ROC	Oak 19.40	4J-35ROMC	Oak 4.80LF
	for 3-1/2" Post		Moulding only
4J-325HC	Hemlock 18.90	4J-325HC	Hemlock 4.48LF
	for 3-1/4" Post		Moulding only

Stair Accessories



ROSETTES

7017
Round



3/4" x 4-3/8"
Oak, Alder \$6.00
Hemlock \$5.00

7037
Oval



3/4" x 4" x 4-5/8"
Oak, Alder \$6.00
Hemlock \$5.00

7017 NC
Round



No Cup
Oak, Alder \$6.00

7037 NC
Oval



No Cup
Oak, Alder \$6.00

Other Species Available
on Quote

1" TAPERED FLAT-GRAIN PLUG
Alder, Oak, Hemlock,
Cherry & Maple

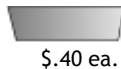

\$.40 ea.

Retail Packed Newel, Baluster & Handrail Installation Hardware

Baluster Bolt Kits

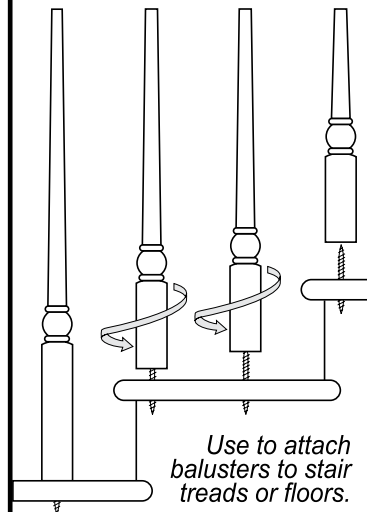

Use to attach
balusters to stair
treads or floors.

#12023 10 pack w/tool \$7.69
#12024 20 pack 6.69
#12025 50 pack 16.29

Handrail Bolt Kit

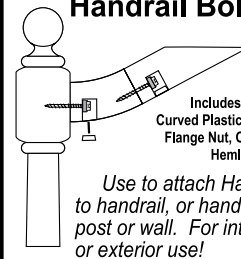

Includes: 4" Bolt,
Curved Plastic Washer,
Flange Nut, Oak Plug,
Hemlock Plug

Use to attach Handrail
to handrail, or handrail to
post or wall. For interior
or exterior use!

Item #11542 \$3.59

Post Bolt Kit

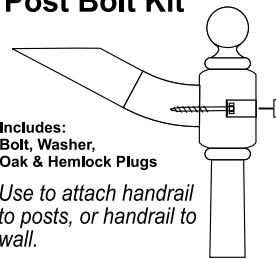

Includes:
Bolt, Washer,
Oak & Hemlock Plugs

Use to attach handrail
to posts, or handrail to
wall.

Item #13042 \$3.79

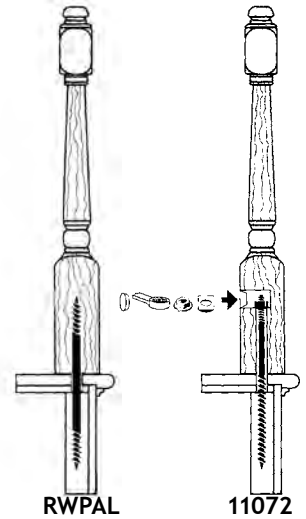

RWPAL

11072

RWPAL - Post Aid Lag
\$7.50

11072 - Newel Post Fastener
\$14.34

CLAMP NAILS \$0.10 Ea.

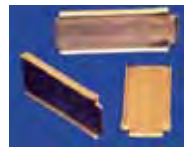

Installation Tool Handrail Bolt Wrench

Item 43221 \$18.00
Easy, Single Handed-Operation
for Installing Handrail Bolts.

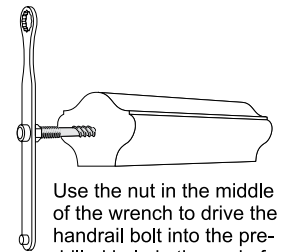

Use the nut in the middle
of the wrench to drive the
handrail bolt into the pre-
drilled hole in the end of
the handrail.

RAIL BOLT
\$1.00 ea.



The Following Items are Stocked in Salt Lake City Only.

RWTRCOE False Tread

Oak \$26.00
12 1/2" x 6"

Maple \$23.00
12 1/2" x 6"

Specify Right or Left Hand

Alder \$22.00
12 1/2" x 6"

Specify Right or Left Hand

TRCR False Riser

6"W x 8"H
Oak \$3.50
Maple 3.50
Alder 2.25

This riser comes with RWTRCOE &
RWTRCWE and included in price



(Nosing & Cove
are attached)

See page 15 for
Denver, Grand
Junction & Casper
Stocked Tread Covers

False Tread & Risers

RWTRCWE Wall Cap

Oak \$13.00
12 1/2" x 6"

Maple \$12.00
Alder \$10.00
12 1/2" x 6"

RWTRCM Molding Tread Nosing & Cover

Oak \$3.50 LF.
Maple 4.05 LF.
Alder 2.25 LF.

Matches molding
on RWTRCOE

Apron Molding

RWA175AO Oak \$2.50
RWA175AM Maple 2.50
RWA175AA Alder 2.50
RWA175AF Fir 3.45
RWA175AC Cherry 5.00

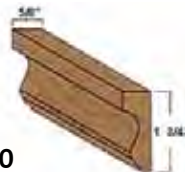

RWBOLT - Rail Bolt, Flange Nut & Cam
\$ 1.70

Rail Bolt Package

Includes: Bolt, Plug and Cam \$2.75 pkg.

RWBOLT-A Alder
RWBOLT-H Hemlock
RWBOLT-M Maple
RWBOLT-RO Oak

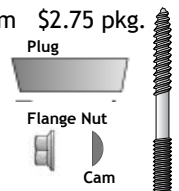

1/2" Plugs - Flat

1500-A 1/2" Alder Plug \$.40 ea
1500-M 1/2" Soft Maple Plug .40 ea

Rail Bolt

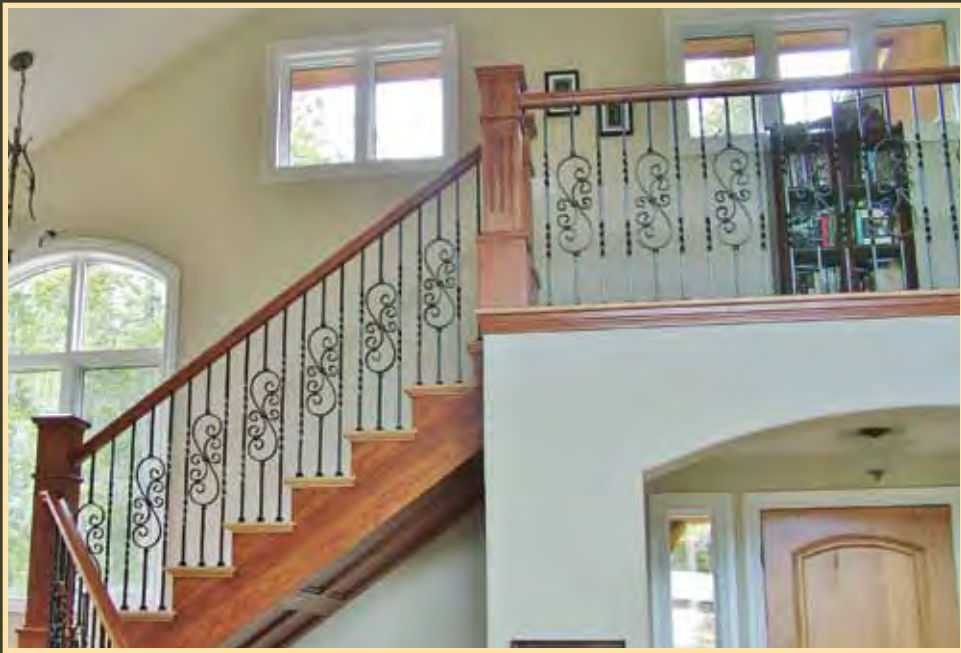



Call for a Quote
on Custom Work.
The Artisans in Our
Mill will be Happy
to Create Yours!

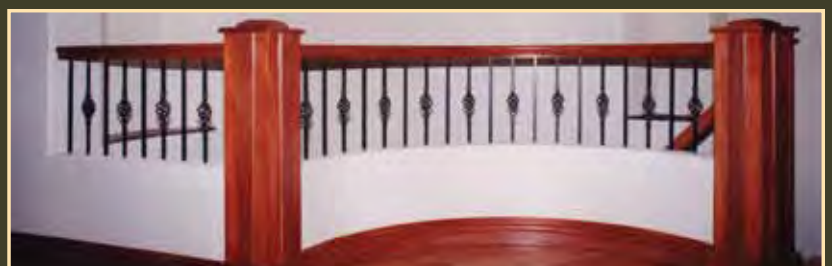
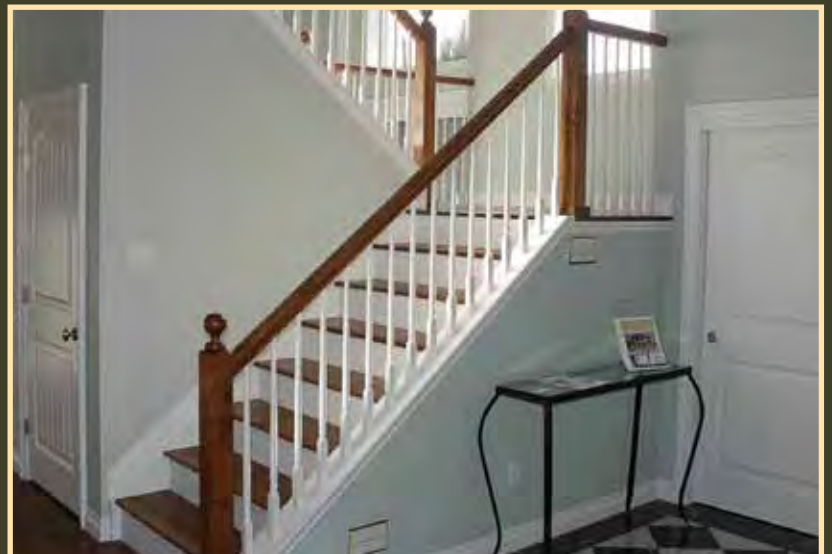

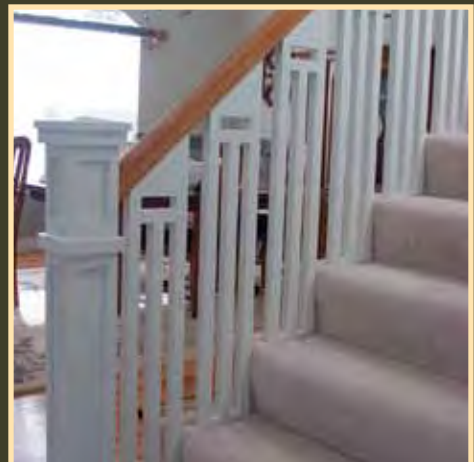

DENVER
 9000 E. 96TH AVENUE
 HENDERSON, CO 80640
 303-289-2226 • 800-332-6682
 FAX 303-288-0080 • FAX 800-545-9183

SALT LAKE CITY
 7454 AIRPORT ROAD
 WEST JORDAN, UT 84084
 (801) 307-0506 • 800-365-1863
 FAX 801-307-0485

CASPER
 4840 N. WARDWELL
 BAR NUNN, WY 82601
 307-266-4568 • 800-442-2475
 FAX 370-265-1411

GRAND JUNCTION
 465 30 ROAD
 GRAND JUNCTION, CO 81504
 970-245-6386 • 800-332-4925
 FAX 970-241-2319

American Stairways, Inc.

Attic Ladders

HUSKY - WOOD DISAPPEARING STAIRWAY

Models 444, 655 & 800*

Re-Inforced Door Panels

3/16" Steel Ladder Rod Under Each Tread

Moulded Stringers, Handrail & Treads

Safety Locknut to Secure Spring Arm to Ladder Section

Rubberized Coated Treads

R-6 Insulation Panel (Fire Doors Only)

Fire Resistant Door (Fire Doors Only)



*Model 800 is an Aluminum Ladder

Fully Assembled
And Ready To Install

Space Saver

Double Section Hinges at Folding Joints
Moulded Handrail

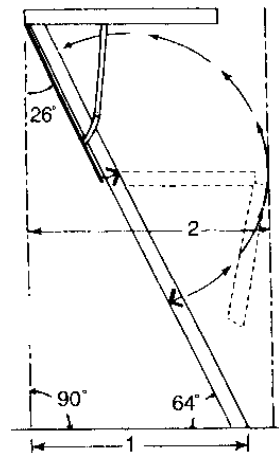

Designed for Residential Use Only

HUSKY ALUMINUM

Strong Lightweight Aluminum Exclusive E-Z Hang™

System Temporary Support Installation Straps

10'-12' Ceiling Heights, Adjustable Feet with Rubber Tread

Stair	Item	Rough	Ceiling	Number	Landing	Projection	List	Max.
Description	Number	Opening	Height	of Treads	Space (1)	(2)	Price	Load
Attic Stair	444-2210	22" x 54"	10'	13	65"	79"	245.07	250 lbs.
Attic Stair/Fire Door	444-2210F	22" x 54"	10'	13	65"	79"	310.05	250 lbs.
Attic Stair	444-2289	22" x 54"	8'9"	11	58"	66"	224.74	250 lbs.
Attic Stair/Fire Door	444-2289F	22" x 54"	8'9"	11	58"	66"	289.00	250 lbs.
Attic Stair	444-2510	25-1/2" x 54"	10'	13	65"	79"	247.05	250 lbs.
Attic Stair	444-2589	25-1/2" x 54"	8'9"	11	58"	66"	226.51	250 lbs.
Attic Stair/Heavy Duty	655-2210	22" x 54"	10'	13	65"	79"	349.15	300 lbs.
Attic Stair/Heavy Duty	655-2289	22" x 54"	8'9"	11	58"	66"	315.59	300 lbs.
Attic Stair/Heavy Duty	655-3010	30" x 54"	10'	13	66"	79"	380.56	300 lbs.
Attic Stair/Heavy Duty	655-3089	30" x 54"	8'9"	11	59"	66"	367.54	300 lbs.
Attic Stair/Aluminum	800-2210	22" x 54"	10'	11	65"	79"	455.19	300 lbs.
Attic Stair/Aluminum	800-2289	22" x 54"	8'9"	9	58"	66"	430.20	300 lbs.
Attic Stair/Aluminum	AL-228P	22-1/2" x 66"	10'-12'	13	81"	89"	856.80	350 lbs.
Attic Stair/Aluminum	AL-258P	25-1/2" x 63"	10'-12'	Variable	90"	92"	892.50	350 lbs.
Attic Stair/Space Saver	BSS-2285	22" x 48"	8'5"	10	56"	60"	410.55	300 lbs.
Attic Stair/Space Saver	BSS-655-2210-5	22" x 60"	10'6"	13	70"	80"	425.21	350 lbs.
Attic Stair/Space Saver	BSS-655-3010-5	30" X 60"	10'6"	13	70"	80"	484.64	350 lbs.